



# 17

## CUPCHAINS & FINDINGS

These products are metal chains and findings that can incorporate either Round or Fancy Stones into any creative design. They can be divided into seven sub-categories: Single Stone Settings, Cupchains and Brass Components, Multi Stone Settings, Channels, Metal Buttons, Rondelles, and Linked Findings. Each of these categories is available in a wide variety of shapes, sizes, colors, and platings.

- SINGLE STONE SETTINGS**
- CUPCHAINS & BRASS COMPONENTS**
- MULTI STONE SETTINGS**
- CHANNELS**
- METAL BUTTONS**
- RONDELLES**
- LINKED FINDINGS**

COLORS & EFFECTS

OPEN TO SEE COLORS & EFFECTS

## COLORS



## EFFECTS<sup>2</sup>



## CRYSTAL PATINA<sup>2</sup>

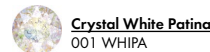

## NUMERICAL ORDER

001	Crystal	207	Montana	243	Capri Blue	294	Chrysolite Opal
001 AB	Crystal Aurora Boreale	208	Siam	246	Light Colorado Topaz	319	Vintage Rose
001 API	Crystal Astral Pink	209	Rose	253	Graphite	327	Indian Siam <sup>1</sup>
001 BBL	Crystal Bermuda Blue**	211	Light Sapphire	257	Blush Rose	360	Erinite
001 GSHA	Crystal Golden Shadow	212	Light Amethyst	259	Tangerine	361	Light Azore
001 HEL	Crystal Heliotrope**	213	Jonquil	261	Light Silk	362	Light Peach
001 LISH	Crystal Lilac Shadow	214	Peridot	262	Rose Peach	371	Violet
001 MOL	Crystal Moonlight	215	Black Diamond	263	Light Turquoise	379	Indicolite
001 PARSH	Crystal Paradise Shine	217	Indian Sapphire	265	Smoky Mauve	383	Light Grey Opal
001 SINI	Crystal Silver Night**	220	Smoked Topaz	266	Denim Blue	390	Pacific Opal
001 SSHA	Crystal Silver Shade	221	Light Smoked Topaz	267	Turquoise	391	Silk
001 VL	Crystal Vitrail Light**	223	Light Rose	277	Purple Velvet	395	Rose Water Opal
001 VM	Crystal Vitrail Medium**	225	Smoky Quartz	280	Jet	398	Cyclamen Opal
001 VOL	Crystal Volcano**	226	Light Topaz	283	Provence Lavender	501	Ruby
001 WHIPA	Crystal White Patina	227	Light Siam	284	Greige	502	Fuchsia
202	Aquamarine	228	Olivine	285	Air Blue Opal	515	Burgundy
203	Topaz	229	Blue Zircon	288	Dark Indigo	539	Tanzanite
204	Amethyst	231	Yellow Opal	289	Indian Pink	542	Padparadscha
205	Emerald	234	White Opal	291	Fern Green		
206	Sapphire	238	Chrysolite	292	Sunflower		

## ALPHABETICAL ORDER

<a href="#">Air Blue Opal (285)</a>	<a href="#">Crystal Silver Shade (001 SSHA)</a>	Light Amethyst (212)	<a href="#">Rose Peach (262)</a>
Amethyst (204)	Crystal Vitrail Light (001 VL)**	Light Azore (361)	Rose Water Opal (395)
Aquamarine (202)	Crystal Vitrail Medium (001 VM)**	Light Colorado Topaz (246)	Ruby (501)
Black Diamond (215)	Crystal Volcano (001 VOL)**	<a href="#">Light Grey Opal (383)</a>	Sapphire (206)
Blue Zircon (229)	<a href="#">Crystal White Patina (001 WHIPA)</a>	Light Peach (362)	Siam (208)
<a href="#">Blush Rose (257)</a>	<a href="#">Cyclamen Opal (398)</a>	Light Rose (223)	Silk (391)
Burgundy (515)	Dark Indigo (288)	Light Sapphire (211)	Smoked Topaz (220)
Capri Blue (243)	<a href="#">Denim Blue (266)</a>	Light Siam (227)	<a href="#">Smoky Mauve (265)</a>
Chrysolite (238)	Emerald (205)	Light Silk (261)	<a href="#">Smoky Quartz (225)</a>
<a href="#">Chrysolite Opal (294)</a>	Erinite (360)	Light Smoked Topaz (221)	Sunflower (292)
Crystal (001)	<a href="#">Fern Green (291)</a>	Light Topaz (226)	<a href="#">Tangerine (259)</a>
<a href="#">Crystal Astral Pink (001 API)</a>	Fuchsia (502)	Light Turquoise (263)	Tanzanite (539)
Crystal Aurora Boreale (001 AB)	<a href="#">Greige (284)</a>	Montana (207)	Topaz (203)
Crystal Bermuda Blue (001 BBL)**	<a href="#">Graphite (253)</a>	Olivine (228)	Turquoise (267)
Crystal Golden Shadow (001 GSHA)	Indian Pink (289)	Pacific Opal (390)	Vintage Rose (319)
Crystal Heliotrope (001 HEL)**	<a href="#">Indian Sapphire (217)</a>	Padparadscha (542)	Violet (371)
<a href="#">Crystal Lilac Shadow (001 LISH)</a>	<a href="#">Indian Siam (327)</a> <sup>1</sup>	Peridot (214)	White Opal (234)
Crystal Moonlight (001 MOL)	Indicolite (379)	Provence Lavender (283)	<a href="#">Yellow Opal (231)</a>
<a href="#">Crystal Paradise Shine (001 PARSH)</a>	Jet (280)	Purple Velvet (277)	
Crystal Silver Night (001 SINI)**	Jonquil (213)	Rose (209)	

For details on available colors and effects for each article within the product groups, please see the product matrix of the respective item in the Collection 2016.  
For color and effect samples, please see the corresponding color chart.

Classic Colors/Effects:  
This color range offers a wide choice of traditional Swarovski crystal colors and effects.

[Exclusive Colors/Effects](#):  
This color range is offered exclusively by Swarovski.

The plating resistance of effects is tested according to Swarovski's plating guidelines (SWAROVSKI.COM/PROFESSIONAL). Customers are advised to carry out their own tests if customers' plating parameters diverge from Swarovski plating guidelines.

\*\* Crystals are resistant to plating only if they are F-failed.  
\*\*\* designed by Jean Paul Gaultier  
<sup>1</sup> The color Indian Siam is available only for a specific size range. Please refer to the current Collection.  
<sup>2</sup> Only plating resistant effects feasible

Colors and effects can appear different when illuminated with different light sources. Swarovski uses standard light source D50 for color decision and comparison. Slight changes in shades are unavoidable. Colors may vary according to cut and foiling.

The composition of Advanced Crystal is compliant with regulatory industry norms and laws regarding the restriction or prohibition of certain substances in the most relevant segments of our customers. Please note that the compliance of the crystal colors Citrine, Fireopal, Hyacinth, Light Siam, Siam and Yellow Opal vary to certain industry regulations. Those regulations are indicated with an (\*) in the compliance overview. Indian Siam (option to Lt. Siam) and Tangerine (option to Sun) conform to all CLEAR-lists.

For further information please visit [swarovski.com/professional](http://swarovski.com/professional)





# CUPCHAINS & FINDINGS

## PLATING DETAILS

Article Group	Available Plating Options
01 Single Stone Settings	(Z) No plating
02 & 09 Cupchains & Brass Components	(G) Gun Metal
03 & 04 Multi Stone Settings <sup>1</sup>	(H) Rhodium
05 Channels	(3) Gold
06 Metal Buttons	(R) Rose Gold
07 Rondelles	
08 Linked Findings	

<sup>1</sup> Stretch articles 31 E02, 37 E00, 37 E02, 37 E04 and 38 E02 are only available with plating.

# CUPCHAINS & FINDINGS

## BASE ITEMS

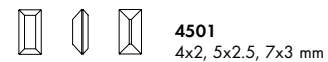
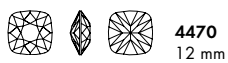
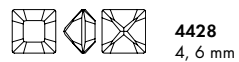
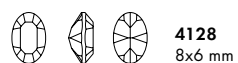
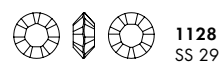
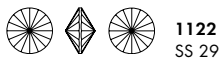
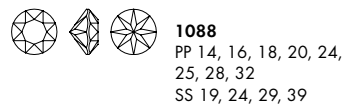
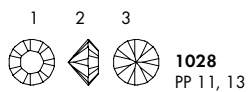





## **SINGLE STONE SETTINGS**

These products are Round or Fancy Stones set in a metal cup, available in a variety of ring and back configurations. Single Stone Settings come in a wide range of shapes and sizes. DIY Findings are also part of this product group.



ARTICLE EXPLANATION - BASE ITEM NUMBER

**17 704** Round



<b>1</b>	<b>7</b>	<b>7</b>	<b>04</b>
Product category	Stone code (type of stone used)	Setting code	Number of prongs in setting (always 2-digit code)
<b>1</b> Single Stone Settings	<b>3</b> Navette <b>5</b> Oval <b>6</b> Pear <b>7</b> Round <b>8</b> Square	<b>0</b> Basic <b>3</b> Navette <b>5</b> Oval <b>6</b> Pear <b>7</b> Round <b>8</b> Square	04 09 10

ORDERING EXAMPLE & PRODUCT VARIETY EXPLANATION - SINGLE STONE SETTINGS

<b>1</b>	<b>17 704</b>	<b>P18</b>	<b>00</b>	<b>E</b>
Material type	Base item number	Stone size	Ring configuration	Back configuration
<b>1</b> Brass		3-digit code from respective product matrix	<b>H2</b> 2 Holes <b>00</b> None <b>1C</b> 1 Ring/Corner <b>1T</b> 1 Ring/Top	<b>A</b> Headpin (0.05x3.81 cm) <b>C</b> Closed <b>E</b> Headpin (0.07x3.81 cm)
<b>F1</b>	<b>3</b>	<b>1088</b>	<b>F</b>	<b>001</b>
Stone pattern	Plating	Base item art. no.	Foiling	Color of crystal
<b>F1</b> Crystal/color/effect	Can be added at an extra charge <b>Z</b> No Plating <b>G</b> Gun Metal <b>3</b> Gold <b>H</b> Rhodium <b>R</b> Rose Gold	1088 4128 4228 4320 4328 4428 4470	<b>F</b> Foiled	Please see the respective color chart at the beginning of this chapter for all available reference codes.

Not all configurations are available for all articles. Please refer to the respective product matrix for all available options.

13 304 Navette

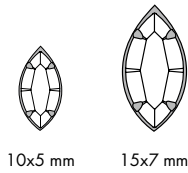

Stone Size		Ring Configuration		Back Configuration		Stone Art. No.	
Code	Description	Code	Description	Code	Description	4228	
10M	10x5 mm	00	None	C	Closed	■	
10M	10x5 mm	1T	1R, Top	C	Closed		
10M	10x5 mm	H2	2 Holes	C	Closed		
X7M	15x7 mm	00	None	C	Closed		■
X7M	15x7 mm	1T	1R, Top	C	Closed		
X7M	15x7 mm	H2	2 Holes	C	Closed		



AVAILABLE COLOR OF CRYSTALS

Please see the respective product matrix for 4228 XILION Navette on page 109 - 110 for all available colors and effects.<sup>1</sup>

Stock Program

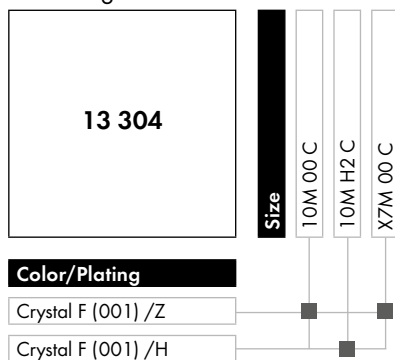

<sup>1</sup> The plating resistance of effects should be considered and can be verified with the Color Chart on page 704



15 504 Oval



8x6 mm

Stone Size		Ring Configuration		Back Configuration		Stone Art. No.
Code	Description	Code	Description	Code	Description	
<b>08M</b>	8x6 mm	<b>1T</b>	1 R, Top	<b>C</b>	Closed	4128
<b>08M</b>	8x6 mm	<b>H2</b>	2 Holes	<b>C</b>	Closed	

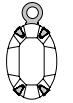
Ring Configuration		Back Configuration
		
1T	H2	Closed

AVAILABLE COLOR OF CRYSTALS

Please see the respective product matrix for 4128 XILION Oval on page 100 for all available colors and effects. <sup>1</sup>

<sup>1</sup> The plating resistance of effects should be considered and can be verified with the Color Chart on page 704

**16 004** Pear

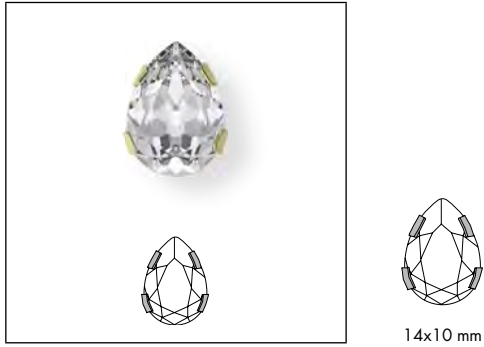

Stone Size		Ring Configuration		Back Configuration		Stone Art. No.
Code	Description	Code	Description	Code	Description	
<b>14M</b>	14x10 mm	<b>1T</b>	1R, Top	<b>C</b>	Closed	4320
<b>14M</b>	14x10 mm	<b>H2</b>	2 Holes	<b>C</b>	Closed	

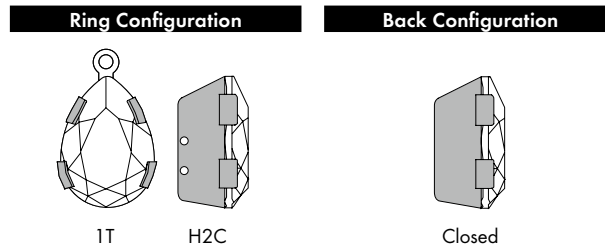

AVAILABLE COLOR OF CRYSTALS

Please see the respective product matrix for 4320 on page 112-113 for all available colors and effects.<sup>1</sup>

Stock Program

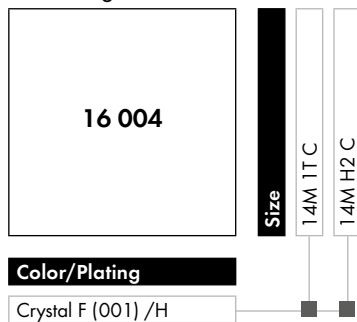

<sup>1</sup> The plating resistance of effects should be considered and can be verified with the Color Chart on page 704

16 604 Pear

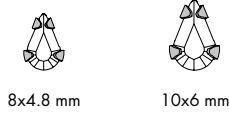

Stone Size		Ring Configuration		Back Configuration		Stone Art. No.
Code	Description	Code	Description	Code	Description	
08M	8x4.8 mm	1T	1 R, Top	C	Closed	4328
08M	8x4.8 mm	H2	2 Holes	C	Closed	
10M	10x6 mm	1T	1 R, Top	C	Closed	
10M	10x6 mm	H2	2 Holes	C	Closed	

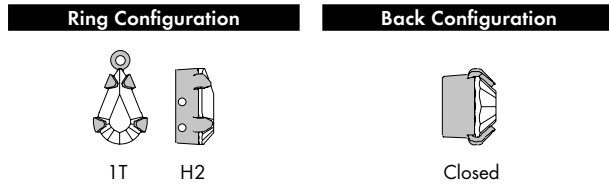

AVAILABLE COLOR OF CRYSTALS

Please see the respective product matrix for 4328 XILION Pear on page 115 for all available colors and effects.<sup>1</sup>

Stock Program

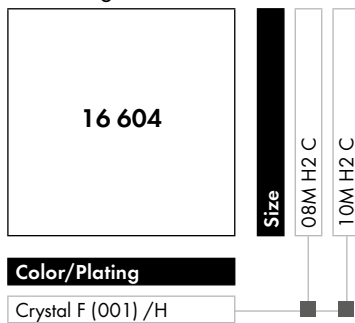

<sup>1</sup> The plating resistance of effects should be considered and can be verified with the Color Chart on page 704

17 009 Round



PP 32

Stone Size		Ring Configuration		Back Configuration		Stone Art. No.
Code	Description	Code	Description	Code	Description	
P32	PP 32	00	None	C	Closed	1088

Back Configuration



Closed

AVAILABLE COLOR OF CRYSTALS

Please see the respective product matrix for 1088 XIRIUS Chaton on page 74-79 for all available colors and effects.<sup>1</sup>

Stock Program

17 009	Size	P32 00 C
<b>Color/Plating</b>		
Crystal F (001) /Z		

<sup>1</sup> The plating resistance of effects should be considered and can be verified with the Color Chart on page 704



17 010 Round



Stone Size		Ring Configuration		Back Configuration		Stone Art. No.
Code	Description	Code	Description	Code	Description	
S29	SS 29	00	None	C	Closed	1088

Back Configuration



Closed

AVAILABLE COLOR OF CRYSTALS

Please see the respective product matrix for 1088 XIRIUS Chaton on page 74-79 for all available colors and effects. <sup>1</sup>

<sup>1</sup> The plating resistance of effects should be considered and can be verified with the Color Chart on page 704

17 704 Round



Stone Size		Ring Configuration		Back Configuration		Stone Art. No.
Code	Description	Code	Description	Code	Description	
P18	PP 18	00	None	A	Headpin (3.81x0.05 cm)	1088
P18	PP 18	00	None	E	Headpin (3.81x0.07 cm)	
P24	PP 24	1T	1R, Top	C	Closed	
P24	PP 24	00	None	A	Headpin (0.05x3.81 cm)	
P24	PP 24	00	None	E	Headpin (0.07x3.81 cm)	
P32	PP 32	1T	1R, Top	C	Closed	
S29	SS 29	1T	1R, Top	C	Closed	
S29	SS 29	H2	2 Holes	C	Closed	
S39	SS 39	1T	1R, Top	C	Closed	
S39	SS 39	H2	2 Holes	C	Closed	

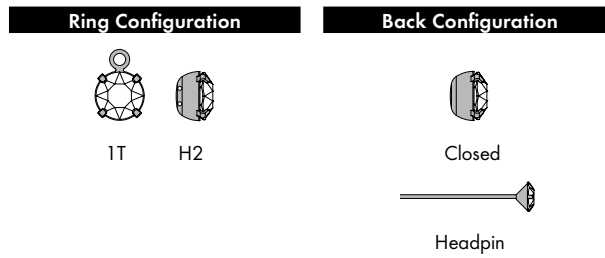

AVAILABLE COLOR OF CRYSTALS

Please see the respective product matrix for 1088 XIRIUS Chaton on page 74-79 for all available colors and effects.<sup>1</sup>

Stock Program

17 704	Size	S29 1T C	S29 H2 C	S39 H2 C
Color/Plating				
Crystal F (001) /Z			■	
Crystal F (001) /H		■	■	■
Light Siam F (227) /3				■



<sup>1</sup> The plating resistance of effects should be considered and can be verified with the Color Chart on page 704

**18 704** Antique Square



Stone Size		Ring Configuration		Back Configuration		Stone Art. No.
Code	Description	Code	Description	Code	Description	
<b>12M</b>	12 mm	<b>1T</b>	1R, Top	<b>C</b>	Closed	4470
<b>12M</b>	12 mm	<b>H2</b>	2 Holes	<b>C</b>	Closed	

Ring Configuration		Back Configuration
		
1T	H2	Closed

AVAILABLE COLOR OF CRYSTALS

Please see the respective product matrix for 4470 on page 123 - 124 for all available colors and effects.<sup>1</sup>

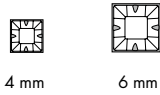

<sup>1</sup> The plating resistance of effects should be considered and can be verified with the Color Chart on page 704

**18 804** Square



Stone Size		Ring Configuration		Back Configuration		Stone Art. No.
Code	Description	Code	Description	Code	Description	
<b>04M</b>	4 mm	<b>1C</b>	1R, Corner	<b>C</b>	Closed	4428
<b>06M</b>	6 mm	<b>1C</b>	1R, Corner	<b>C</b>	Closed	
<b>06M</b>	6 mm	<b>H2</b>	2 Holes	<b>C</b>	Closed	

Ring Configuration		Back Configuration
		
1C	H2	Closed

AVAILABLE COLOR OF CRYSTALS

Please see the respective product matrix for 4428 XILION Square on page 119-120 for all available colors and effects.<sup>1</sup>

<sup>1</sup> The plating resistance of effects should be considered and can be verified with the Color Chart on page 704

## PRODUCT DETAILS

Article Stone Article Number	Stone Size
<b>13 304</b> Navette	
4228	10x5 mm
4228	15x7 mm
<b>15 504</b> Oval	
4128	8x6 mm
<b>16 004</b> Pear	
4320	14x10 mm
<b>16 604</b> Pear	
4328	8x4.8 mm
4328	10x6 mm
<b>17 009</b> Round	
1088	PP 32
<b>17 010</b> Round	
1088	SS 29
<b>17 704</b> Round	
1088	PP 18
1088	PP 24
1088	PP 32
1088	SS 29
1088	SS 39
<b>18 704</b> Antique Square	
4470	12 mm
<b>18 804</b> Square	
4428	4 mm
4428	6 mm







## **CUPCHAINS & BRASS COMPONENTS**

Cupchains are metal chains that integrate Round or Fancy Stones. Cupchains are offered in a large variety of shapes, sizes, colors, and platings.

Brass Components are end fasteners that match Cupchains from our assortment, including Lobster Claws for easy application.

ARTICLE EXPLANATION - BASE ITEM NUMBER

**27 004** Round Cupchain



<b>2</b>	<b>7</b>	<b>0</b>	<b>04</b>
Product category	Stone code (type of stone used)	Setting code	Number of prongs in the setting (always 2-digit code)
<b>2</b> Cupchains	<b>1</b> Baguette <b>3</b> Navette <b>7</b> Round <b>8</b> Square	<b>0</b> Basic <b>1</b> Extended <b>3</b> Solitaire	00 Bezel 01 Catch-Free 02 D4 Snake 04 08

ORDERING EXAMPLE & PRODUCT VARIETY EXPLANATION - CUPCHAINS

<b>1</b>	<b>27 004</b>	<b>P24</b>	<b>00</b>	<b>C</b>
Material type	Base item number	Stone size	Ring configuration	Back configuration
<b>1</b> Brass		3-digit code from respective product matrix	<b>00</b> None	<b>C</b> Closed <b>O</b> Open
<b>C1</b>	<b>Z</b>	<b>1028</b>	<b>F</b>	<b>001</b>
Stone pattern	Plating	Base item art. no.	Foiling	Color of crystal
<b>A1</b> Crystal with effect <b>C1</b> Color <b>K1</b> Crystal <b>02</b> 2 alternate colors <b>03</b> 3 alternate colors	Can be added at an extra charge <b>Z</b> No Plating <b>G</b> Gun Metal <b>3</b> Gold <b>H</b> Rhodium <b>R</b> Rose Gold	1028 1088 4228 4428 4501	<b>F</b> Foiled	Please see the respective color chart at the beginning of this chapter for all available reference codes.

Not all configurations are available for all articles. Please refer to the respective product matrix for available combinations.

ORDERING EXAMPLE & PRODUCT VARIETY  
EXPLANATION - BRASS COMPONENTS

**00 011** Crimp Spring Ring (Cupchain end)

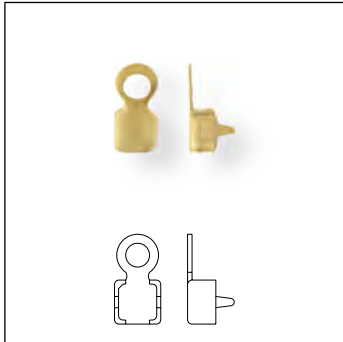

<b>1</b>	<b>00 011</b>	<b>000</b>	<b>00</b>	<b>0</b>	<b>Z</b>
Material type	Base item number	No stone	No ring configuration	No back configuration	Plating
<b>1</b> Brass	Number above product picture always starting with 0				Can be added at an extra charge.  <b>Z</b> No Plating <b>G</b> Gun Metal <b>3</b> Gold <b>H</b> Rhodium <b>R</b> Rose Gold

21 004 Baguette

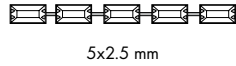

Stone Size		Ring Configuration		Back Configuration		Stone Art. No.
Code	Description	Code	Description	Code	Description	
05M	5x2.5 mm	00	None	C	Closed	4501

  

Back Configuration	
Code	Description
	Closed

AVAILABLE COLOR OF CRYSTALS

Please see the respective product matrix for 4501 on page 129 for all available colors and effects.<sup>1</sup>

Stock Program

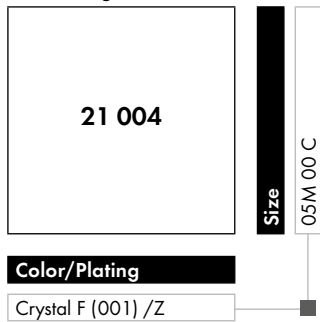

<sup>1</sup> The plating resistance of effects should be considered and can be verified with the Color Chart on page 704

21 0D4 Snake Chain

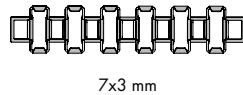
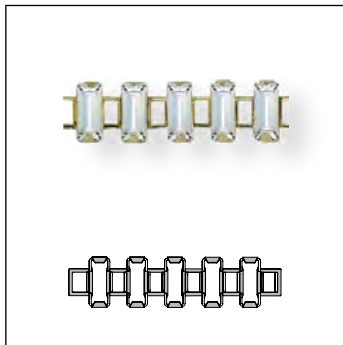

Stone Size		Ring Configuration		Back Configuration		Stone Art. No.	use Cupchain end Art. No.
Code	Description	Code	Description	Code	Description	4501	05 95S
07M	7x3 mm	00	None	C	Closed		

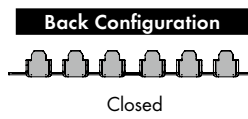

AVAILABLE COLOR OF CRYSTALS

Please see the respective product matrix for 4501 on page 129 for all available colors and effects.<sup>1</sup>

23 004 Navette Chain

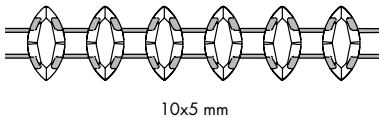

Stone Size		Ring Configuration		Back Configuration		Stone Art. No.
Code	Description	Code	Description	Code	Description	4228
10M	10x5 mm	00	None	C	Closed	

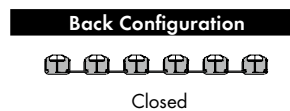

AVAILABLE COLOR OF CRYSTALS

Please see the respective product matrix for 4228 on page 109-110 for all available colors and effects.<sup>1</sup>

<sup>1</sup> The plating resistance of effects should be considered and can be verified with the Color Chart on page 704



27 000 Bezel Chain

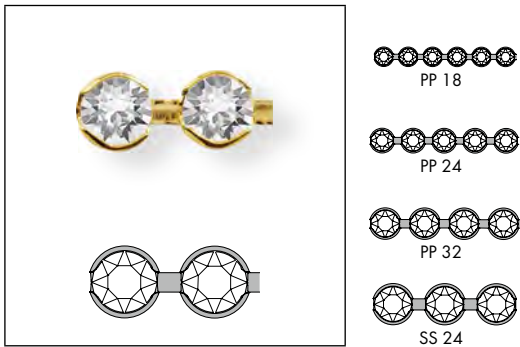

Stone Size		Ring Configuration		Back Configuration		Stone Art. No.	use Cupchain end Art. No.
Code	Description	Code	Description	Code	Description		
<b>P18</b>	PP 18	<b>00</b>	None	<b>C</b>	Closed	1088	05 94B
<b>P24</b>	PP 24	<b>00</b>	None	<b>C</b>	Closed		05 82B
<b>P32</b>	PP 32	<b>00</b>	None	<b>C</b>	Closed		05 83B
<b>S24</b>	SS 24	<b>00</b>	None	<b>C</b>	Closed		-

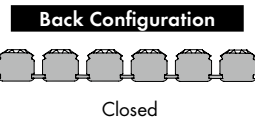

AVAILABLE COLOR OF CRYSTALS

Please see the respective product matrix for 1088 XIRIUS Chaton on page 74-79 for all available colors and effects.<sup>1</sup>

Stock Program

Color/Plating	Size		
	P18.00 C	P24.00 C	P32.00 C
Crystal F (001) /Z	■	■	■
Crystal F (001) /3		■	■
Crystal F (001) /H		■	
Aquamarine F (202) /Z		■	
Black Diamond F (215) /Z			■
White Opal F (234) /Z		■	

<sup>1</sup> The plating resistance of effects should be considered and can be verified with the Color Chart on page 704

**27 001** Catch-free Cupchain

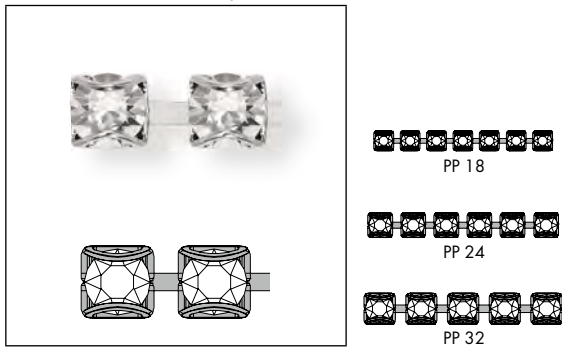

Stone Size		Ring Configuration		Back Configuration		Stone Art. No.	use Cupchain end Art. No.
Code	Description	Code	Description	Code	Description		
<b>P18</b>	PP 18	<b>00</b>	None	<b>C</b>	Closed	1088	00 594
<b>P24</b>	PP 24	<b>00</b>	None	<b>C</b>	Closed		00 582
<b>P32</b>	PP 32	<b>00</b>	None	<b>C</b>	Closed		-

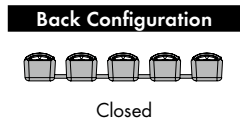

AVAILABLE COLOR OF CRYSTALS

Please see the respective product matrix for 1088 XIRIUS Chaton on page 74-79 for all available colors and effects.<sup>1</sup>

Stock Program

Color/Plating	Size		
	P18 00 C	P24 00 C	P32 00 C
Crystal F (001) /Z	■		
Crystal F (001) /3			■
Crystal F (001) /H		■	■
Crystal F (001) /R	■		
Cr.Gold.Shadow F(001 GSHA)/R			■

<sup>1</sup> The plating resistance of effects should be considered and can be verified with the Color Chart on page 704

27 004 Round

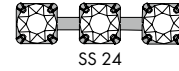
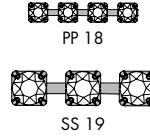
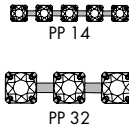
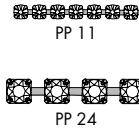

Stone Size		Ring Configuration		Back Configuration		Stone Art. No.		use Cupchain end Art. No.
Code	Description	Code	Description	Code	Description	1028	1088	
P11	PP 11	00	None	C	Closed	■		00 011
P14	PP 14	00	None	C	Closed		■	00 286
P18	PP 18	00	None	C	Closed		■	00 594
P24	PP 24	00	None	C	Closed		■	00 582
P32	PP 32	00	None	C	Closed		■	00 583
S19	SS 19	00	None	C	Closed		■	-
S24	SS 24	00	None	C	Closed		■	00 249

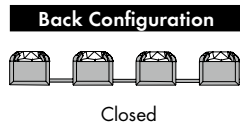

AVAILABLE COLOR OF CRYSTALS

Please see the respective product matrix for 1088 XIRIUS Chaton on page 74-79 for all available colors and effects.<sup>1</sup>

Stock Program

Size	P11 00 C	P14 00 C	P18 00 C	P24 00 C	P32 00 C	S19 00 C
<b>27 004</b>						
<b>Color/Plating</b>						
Crystal F (001) /Z	■	■	■	■	■	
Crystal F (001) /3		■				
Crystal F (001) /H	■	■	■	■	■	■
Crystal F AB (001 AB) /Z		■				
Cr.Gold.Shadow F(001.GSHA)/H	■					

Stock Program

Size	P11 00 C	P14 00 C	P18 00 C	P24 00 C	P32 00 C	S19 00 C
<b>27 004</b>						
<b>Color/Plating</b>						
Black Diamond F (215) /Z		■	■			
Jet F (280) /Z		■	■			
Light Amethyst F (212) /Z			■			
Pacific Opal F (390) /Z	■	■	■			
White Opal F (234) /Z		■	■			

<sup>1</sup> The plating resistance of effects should be considered and can be verified with the Color Chart on page 704

27 104 Round Extended

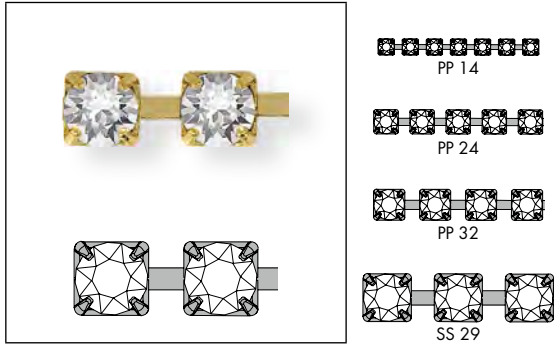

Stone Size		Ring Configuration		Back Configuration		Stone Art. No.	use Cupchain end Art. No.
Code	Description	Code	Description	Code	Description		
<b>P14</b>	PP 14	<b>00</b>	None	<b>C</b>	Closed	1088	00 286
<b>P24</b>	PP 24	<b>00</b>	None	<b>C</b>	Closed		00 582
<b>P32</b>	PP 32	<b>00</b>	None	<b>C</b>	Closed		00 583
<b>S29</b>	SS 29	<b>00</b>	None	<b>C</b>	Closed		00 029

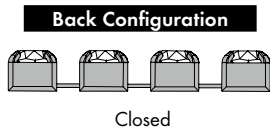

AVAILABLE COLOR OF CRYSTALS

Please see the respective product matrix for 1088 XIRIUS Chaton on page 74-79 for all available colors and effects.<sup>1</sup>

Stock Program

Color/Plating	Size			
	P14 00 C	P24 00 C	P32 00 C	S29 00 C
Crystal F (001) /Z	■	■	■	■
Crystal F (001) /H		■	■	■
Black Diamond (215) /Z		■		
Jet (280) /Z		■		
White Opal F (234) /Z		■	■	

<sup>1</sup> The plating resistance of effects should be considered and can be verified with the Color Chart on page 704

**27 308** Round Solitaire

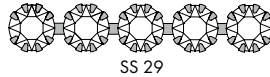

Stone Size		Ring Configuration		Back Configuration		Stone Art. No.	use Cupchain end Art. No.
Code	Description	Code	Description	Code	Description	1088	
<b>S29</b>	SS 29	<b>00</b>	None	<b>C</b>	Closed		00 029

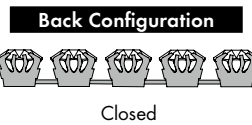

AVAILABLE COLOR OF CRYSTALS

Please see the respective product matrix for 1088 XIRIUS Chaton on page 74-79 for all available colors and effects.<sup>1</sup>

Stock Program

<b>27 308</b>	<b>Size</b> S29 00 C
<b>Color/Plating</b>	
Crystal F (001) /Z	■
Crystal F (001) /G	■
Crystal F (001) /3	■
Crystal F (001) /H	■
Crystal AB F (001 AB) /3	■
Crystal AB F (001 AB) /H	■
Cr. Golden Shadow F (001 GSHA) /3	■
Black Diamond F (215) /H	■
Jet (280) /3	■
Lt. Colorado Topaz F (246) /3	■
Pacific Opal F (390) /3	■
White Opal F (234) /3	■

<sup>1</sup> The plating resistance of effects should be considered and can be verified with the Color Chart on page 704

**28 002** Square

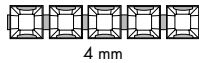
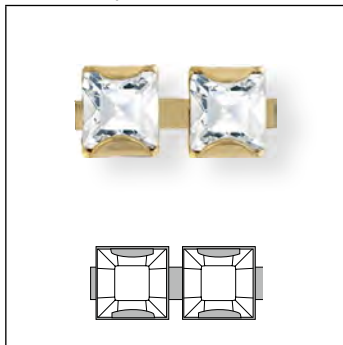

Stone Size		Ring Configuration		Back Configuration		Stone Art. No.	use Cupchain end Art. No.
Code	Description	Code	Description	Code	Description	4428	00 256
04M	4 mm	00	None	C	Closed		

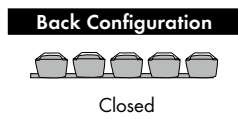

AVAILABLE COLOR OF CRYSTALS

Please see the respective product matrix for 4428 XILION Square on page 119-120 for all available colors and effects.<sup>1</sup>

Stock Program

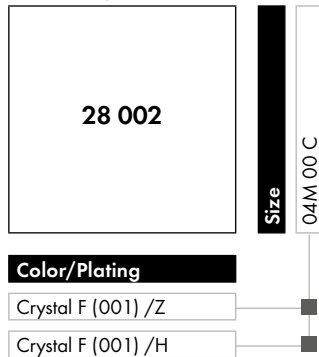

<sup>1</sup> The plating resistance of effects should be considered and can be verified with the Color Chart on page 704

CUPCHAIN END FOR SNAKE CHAIN

**05 95S** Snake Chain Spring Ring

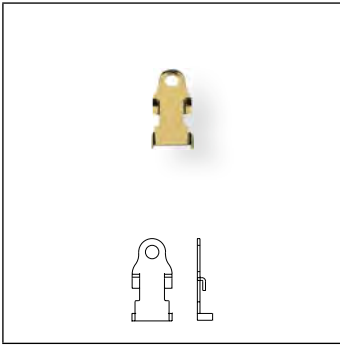

Base Item No.		Ring Configuration		Back Configuration		For Stone Size	For Cupchain
Code	Description	Code	Description	Code	Description	7x3 mm	21 OD4 07 M
000	None	00	None	0	None		

CUPCHAIN ENDS FOR BEZEL CHAIN

**05 94B** Bezel Crimp Spring Ring

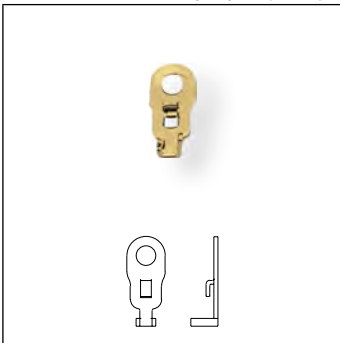

Base Item No.		Ring Configuration		Back Configuration		For Stone Size	For Cupchain
Code	Description	Code	Description	Code	Description	PP 18	27 000 P18
000	None	00	None	0	None		

**05 82B** Bezel Crimp Spring Ring

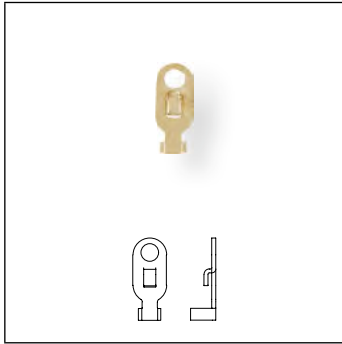

Base Item No.		Ring Configuration		Back Configuration		For Stone Size	For Cupchain
Code	Description	Code	Description	Code	Description	PP 24	27 000 P24
000	None	00	None	0	None		

**05 83B** Bezel Crimp Spring Ring

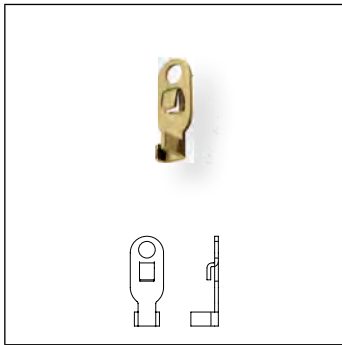

Base Item No.		Ring Configuration		Back Configuration		For Stone Size	For Cupchain
Code	Description	Code	Description	Code	Description	PP 32	27 000 P32
000	None	00	None	0	None		

Stock Program

<b>05 83B</b>	<b>For Stone Size</b>	PP 32
<b>Color/Plating</b>		
Rhodium (H)		



CUPCHAIN ENDS BASIC

**00 011** Crimp Spring Ring

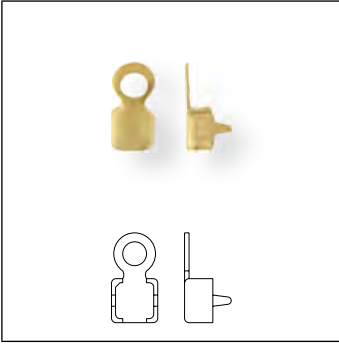

Base Item No.		Ring Configuration		Back Configuration		For Stone Size	For Cupchain
Code	Description	Code	Description	Code	Description	PP 11	
000	None	00	None	0	None		

**00 286** Crimp Spring Ring

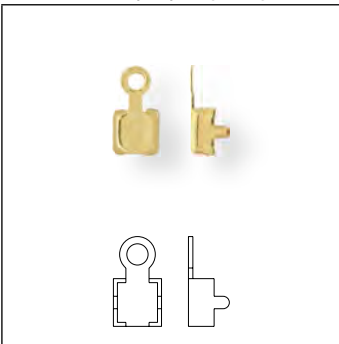

Base Item No.		Ring Configuration		Back Configuration		For Stone Size	For Cupchain
Code	Description	Code	Description	Code	Description	PP 14	
000	None	00	None	0	None		

**00 594** Crimp Spring Ring

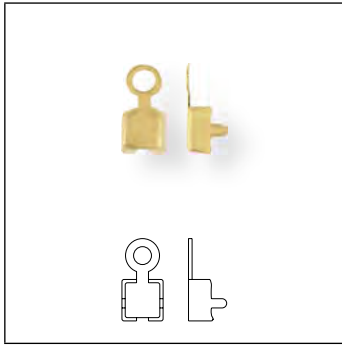

Base Item No.		Ring Configuration		Back Configuration		For Stone Size	For Cupchain
Code	Description	Code	Description	Code	Description	PP 18	
000	None	00	None	0	None		

**00 582** Crimp Spring Ring

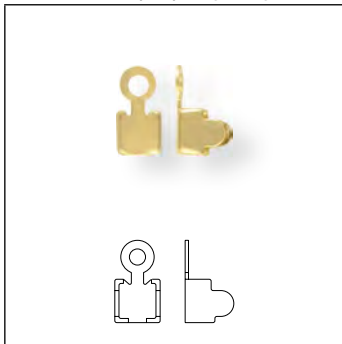

Base Item No.		Ring Configuration		Back Configuration		For Stone Size	For Cupchain
Code	Description	Code	Description	Code	Description	PP 24	
000	None	00	None	0	None		

Stock Program

<b>00 582</b>	<b>For Stone Size</b>	PP 24
<b>Color/Plating</b>		
Gold (3)		■
Rhodium (H)		■

**00 583** Crimp Spring Ring

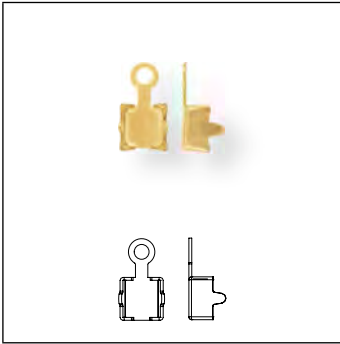

Base Item No.		Ring Configuration		Back Configuration		For Stone Size	For Cupchain
Code	Description	Code	Description	Code	Description		
000	None	00	None	0	None	PP 32	27 001 P32 27 004 P32 27 104 P32

Stock Program

**00 583**

For Stone Size  
PP 32

**Color/Plating**

Gold (3)

Rhodium (H)

**00 029** Crimp Spring Ring

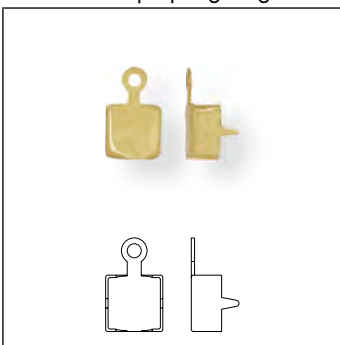

Base Item No.		Ring Configuration		Back Configuration		For Stone Size	For Cupchain
Code	Description	Code	Description	Code	Description		
000	None	00	None	0	None	SS 29	27 104 S29 27 308 S29

**00 256** Crimp Foldover

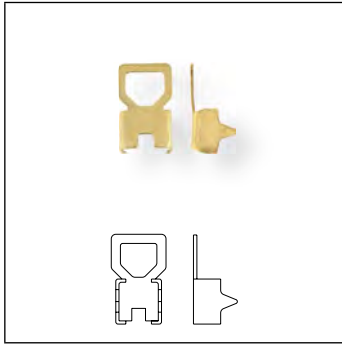

Base Item No.		Ring Configuration		Back Configuration		For Stone Size	For Cupchain
Code	Description	Code	Description	Code	Description		
000	None	00	None	0	None	4 mm	28 002 4 mm

**00 249** Crimp Spring Ring

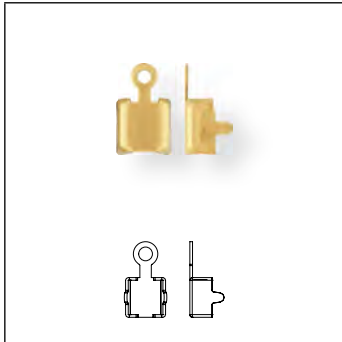

Base Item No.		Ring Configuration		Back Configuration		For Stone Size	For Cupchain
Code	Description	Code	Description	Code	Description		
000	None	00	None	0	None	SS 24	27 004 SS24

**01 255** Lobster Claw Small



Base Item No.		Ring Configuration		Back Configuration	
Code	Description	Code	Description	Code	Description
000	None	00	None	0	None

**01 256** Lobster Claw Large

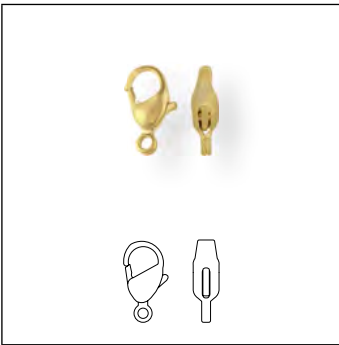

Base Item No.		Ring Configuration		Back Configuration	
Code	Description	Code	Description	Code	Description
000	None	00	None	0	None

## PRODUCT DETAILS

Article Stone Article Number	Stone Size	Stones per meter	Stones per foot	Recommended Cupchains end Article Number
<b>21 004</b>				
4501	5x2.5 mm	143	44	-
<b>21 0D4</b>				
4501	7x3 mm	186	57	05 95S
<b>23 004</b>				
4228	10x5 mm	128	39	-
<b>27 000</b>				
1088	PP 18	273	83	05 94B
1088	PP 24	220	67	05 82B
1088	PP 32	171	52	05 83B
1088	SS 24	139	42	-
<b>27 001</b>				
1088	PP 18	275	84	00 594
1088	PP 24	223	68	00 582
1088	PP 32	177	54	00 583
<b>27 004</b>				
1028	PP 11	392	119	00 011
1088	PP 14	344	105	00 286
1088	PP 18	273	83	00 594
1088	PP 24	222	68	00 582
1088	PP 32	169	52	00 583
1088	SS 19	139	42	-
1088	SS 24	139	42	00 249
<b>27 104</b>				
1088	PP 14	326	99	00 286
1088	PP 24	201	61	00 582
1088	PP 32	157	48	00 583
1088	SS 29	132	41	00 029
<b>27 308</b>				
1088	SS 29	125	38	00 029
<b>28 002</b>				
4428	4 mm	204	62	00 256



### **MULTI STONE SETTINGS**

These products incorporate Round or Fancy Stones, set in special metal shapes such as circles, crosses or balls. Stretch Bracelets are also included in this group.



ARTICLE EXPLANATION - BASE ITEM NUMBER  
STRETCH BRACELET

**37 E00** Bezel Stretch Chain



<b>3/4</b>	<b>7</b>	<b>E</b>	<b>00</b>
Product category	Stone code (type of stone used)	Setting code	Number of prongs or stones in the setting (always 2 digit code)
<b>3</b> Multi Stone Settings <b>4</b> Fancy Multi Settings	<b>1</b> Baguette <b>7</b> Round <b>8</b> Square	<b>E</b> Stretch Chain <b>1</b> Double Setting <b>2</b> Cross <b>4</b> Rondelle Ball <b>5</b> Ball <b>6</b> Graduated <b>7</b> Circle	<b>00</b> Bezel <b>02</b> <b>03</b> <b>04</b> <b>05</b> <b>08</b> <b>10</b> <b>14</b> <b>20</b>

ORDERING EXAMPLE  
& PRODUCT VARIETY EXPLANATION

<b>1</b>	<b>37 E00</b>	<b>P32</b>	<b>18</b>	<b>C</b>
Material type	Base item number	Stone size	Ring configuration	Back configuration
<b>1</b> Brass		3-digit code from respective product matrix.	<b>00</b> None <b>18</b> 18 cm <b>1T</b> 1 Ring/Top	<b>1</b> Channel <b>C</b> Closed <b>H</b> Hole (1 mm)
<b>F1</b>	<b>Z</b>	<b>1088</b>	<b>F</b>	<b>001</b>
Stone pattern	Plating	Base item art. no.	Foiling	Color of crystal
<b>F1</b> Crystal/color/ effect	Can be added at an extra charge  <b>Z</b> No Plating <b>G</b> Gun Metal <b>3</b> Gold <b>H</b> Rhodium <b>R</b> Rose Gold  Stretch articles 31 E02, 37 E00, 37 E02, 37 E04 and 38 E02 are only available with plating.	1088 4428 4501	<b>F</b> Foiled	Please see the respective color chart at the beginning of this chapter for all available reference codes.

Not all configurations are available for all articles. Please refer to the respective product matrix for available combinations.

**31 E02** Snake Chain Stretch Bracelet

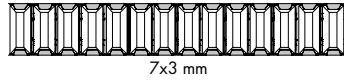
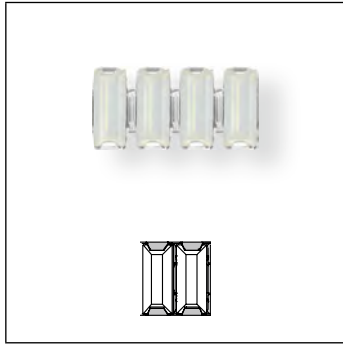

Stone Size		Ring Configuration		Back Configuration		Stone Art. No.	Diameter
Code	Description	Code	Description	Code	Description	4501	55.0 mm
07M	7x3 mm	18	170.0 mm	C	Closed		

**Back Configuration**

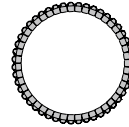

Closed

AVAILABLE COLOR OF CRYSTALS

Please see the respective product matrix for 4501 on page 129 for all available colors and effects.<sup>1</sup>

Stock Program

<b>31 E02</b>	<b>Size</b> 07M 18 C
<b>Color/Plating</b>	
Crystal F (001) /H	

<sup>1</sup> The plating resistance of effects should be considered and can be verified with the Color Chart on page 704

37 E00 Bezel Stretch Chain

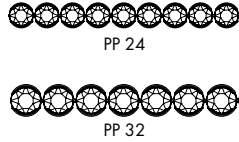

Stone Size		Ring Configuration		Back Configuration		Stone Art. No.	Diameter
Code	Description	Code	Description	Code	Description	1088	
P24	PP 24	18	177.8 mm	C	Closed		54.0 mm
P32	PP 32	18	170 mm	C	Closed		55.0 mm

Back Configuration

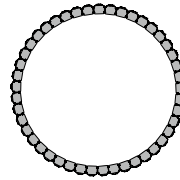

Closed

AVAILABLE COLOR OF CRYSTALS

Please see the respective product matrix for 1088 XIRIUS Chaton on page 74-79 for all available colors and effects.<sup>1</sup>

Stock Program

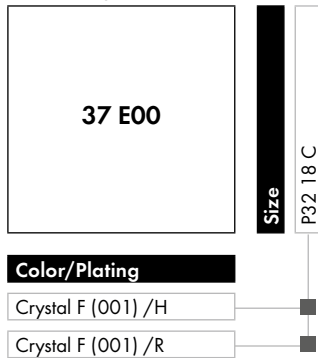

<sup>1</sup> The plating resistance of effects should be considered and can be verified with the Color Chart on page 704

ARTICLE EXPLANATION

**37 E02** Catch-free Stretch Bracelet



Stone Size		Ring Configuration		Back Configuration		Stone Art. No.	Diameter
Code	Description	Code	Description	Code	Description	1088	
<b>P32</b>	PP 32	<b>18</b>	170 mm	<b>C</b>	Closed		55 mm

**Back Configuration**

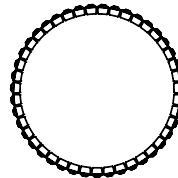

Closed

AVAILABLE COLOR OF CRYSTALS

Please see the respective product matrix for 1088 XIRIUS Chaton on page 74-79 for all available colors and effects.<sup>1</sup>

Stock Program

<b>37 E02</b>	<b>Size</b> P32 18 C
<b>Color/Plating</b>	
Crystal F (001) /H	

<sup>1</sup> The plating resistance of effects should be considered and can be verified with the Color Chart on page 704

# CUPCHAINS & FINDINGS

# MULTI STONE SETTINGS

## CATCH FREE FLAG STRETCH BRACELETS

**37 E02** Stretch Bracelet "AUSTRIA, CANADA, JAPAN"

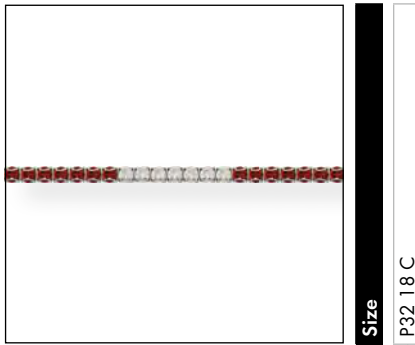

**Size**  
P32 18 C

**Article** 137E02P3218C FIH 1088 F  
FLAG 227 234

**System Number** 1466104

**Colors**

- Light Siam (227)
- White Opal (234)

**37 E02** Stretch Bracelet "GERMANY, BELGIUM"

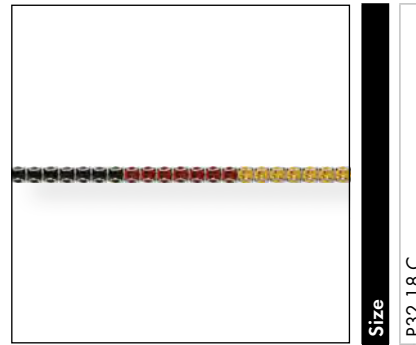

**Size**  
P32 18 C

**Article** 137E02P3218C FIH 1088 F  
FLAG 280 227 226

**System Number** 1466105

**Colors**

- Jet (280)
- Light Siam (227)
- Light Topaz (226)

**37 E02** Stretch Bracelet "USA, FRANCE, UK, NED, AUS, NZL"

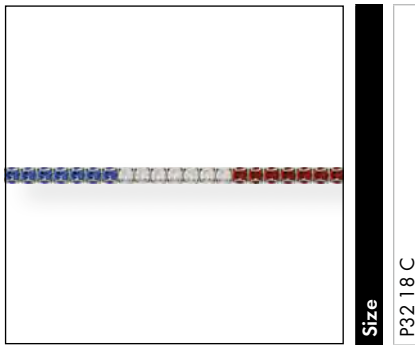

**Size**  
P32 18 C

**Article** 137E02P3218C FIH 1088 F  
FLAG 206 234 227

**System Number** 1466107

**Colors**

- Sapphire (206)
- White Opal (234)
- Light Siam (227)

**37 E02** Stretch Bracelet "BRAZIL"

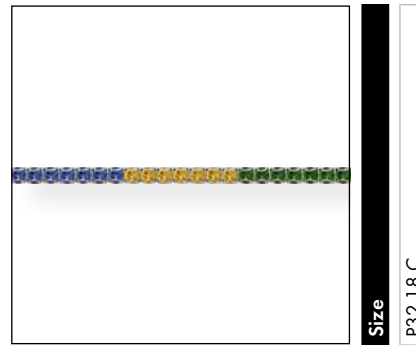

**Size**  
P32 18 C

**Article** 137E02P3218C FIH 1088 F  
FLAG 206 226 291

**System Number** 1466108

**Colors**

- Sapphire (206)
- Light Topaz (226)
- Fern Green (291)

## CUPCHAINS & FINDINGS

## MULTI STONE SETTINGS

### 37 E02 Stretch Bracelet "ITALY, MEXICO"

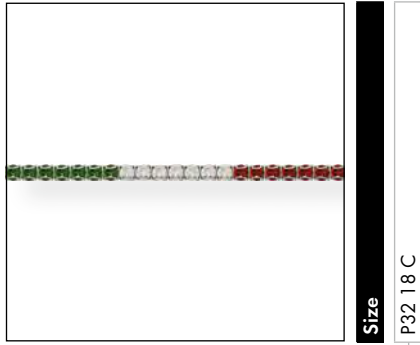



Size

P32 18 C

Article 137E02P3218C F1H 1088 F  
FLAG 291 234 227

System Number 1466109

#### Colors

-  Fern Green (291)
-  White Opal (234)
-  Light Siam (227)

### 37 E02 Stretch Bracelet "INDIA, IRELAND"





Size

P32 18 C

Article 137E02P3218C F1H 1088 F  
FLAG 291 234 259

System Number 1466110

#### Colors

-  Fern Green (291)
-  White Opal (234)
-  Tangerine (259)

### 37 E02 Stretch Bracelet "SPAIN"

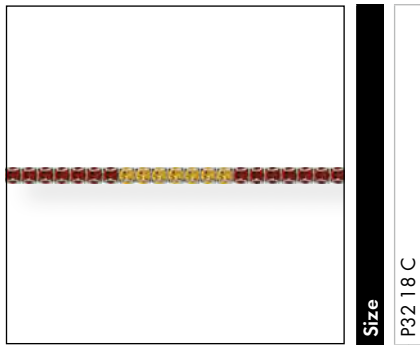

Size

P32 18 C

Article 137E02P3218C F1H 1088 F  
FLAG 227 226

System Number 1466111

#### Colors

-  Light Siam (227)
-  Light Topaz (226)

37 E04 Stretch Chain



Stone Size		Ring Configuration		Back Configuration		Stone Art. No.	Diameter
Code	Description	Code	Description	Code	Description	1088	
P24	PP 24	18	177.8 mm	C	Closed		55.1 mm
P32	PP 32	18	173.0 mm	C	Closed		53.3 mm

Back Configuration



Closed

AVAILABLE COLOR OF CRYSTALS

Please see the respective product matrix for 1088 XIRIUS Chaton on page 74-79 for all available colors and effects. <sup>1</sup>

Stock Program

Color/Plating	Size	
	P24 18 C	P32 18 C
Crystal F (001) /H	■	■
Crystal F (001) /3	■	
Crystal AB F (001AB) /H		■
Cr. Golden Shadow F (001 GSHA) /3		■
Amethyst F (204) /H	■	
Aquamarine F (202) /H	■	
Jet (280) /H	■	

<sup>1</sup> The plating resistance of effects should be considered and can be verified with the Color Chart on page 704

**38 E02** Square Stretch Chain

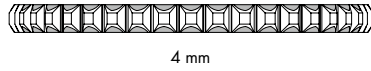
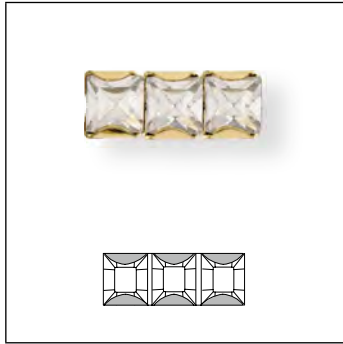

Stone Size		Ring Configuration		Back Configuration		Stone Art. No.	Diameter
Code	Description	Code	Description	Code	Description	4428	55.0 mm
04M	4 mm	18	170.0 mm	C	Closed		

**Back Configuration**

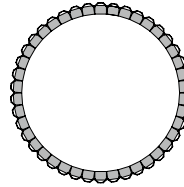

Closed

AVAILABLE COLOR OF CRYSTALS

Please see the respective product matrix for 4428 XILLION Square on pag 119-120 for all available colors and effects. <sup>1</sup>

Stock Program

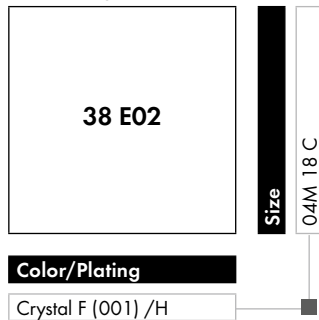

<sup>1</sup> The plating resistance of effects should be considered and can be verified with the Color Chart on page 704



**37 102** Double Setting



SS 39

Stone Size		Ring Configuration		Back Configuration		Stone Art. No.		Dimensions
Code	Description	Code	Description	Code	Description			
<b>S39</b>	SS 19, SS 39	<b>1T</b>	1R, Top	<b>C</b>	Closed	1088	1088	115.8x71.1 mm

**Ring Configuration**



1T

AVAILABLE COLOR OF CRYSTALS

Please see the respective product matrix for 1088 XIRIUS Chaton on page 74-79 for all available colors and effects.<sup>1</sup>

<sup>1</sup> The plating resistance of effects should be considered and can be verified with the Color Chart on page 704

37 714 Circle



PP 18  
15.6 mm

Stone Size		Ring Configuration		Back Configuration		Stone Art. No.	Diameter
Code	Description	Code	Description	Code	Description	1088	15.6 mm
P18	PP 18	00	None	1	Channel		

Back Configuration

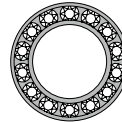

Channel

AVAILABLE COLOR OF CRYSTALS

Please see the respective product matrix for 1088 XIRIUS Chaton on page 74-79 for all available colors and effects.<sup>1</sup>

Stock Program

<b>37 714</b>	<b>Size</b>	P18.00 1
	<b>Color/Plating</b>	
	Crystal F (001) /H	■
Crystal F (001) /3	■	

<sup>1</sup> The plating resistance of effects should be considered and can be verified with the Color Chart on page 704

37 720 Circle



PP 18  
21.4 mm

Stone Size		Ring Configuration		Back Configuration		Stone Art. No.	Diameter
Code	Description	Code	Description	Code	Description	1088	21.4 mm
P18	PP 18	00	None	1	Channel		

Back Configuration

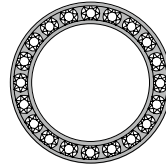

Channel

AVAILABLE COLOR OF CRYSTALS

Please see the respective product matrix for 1088 XIRIUS Chaton on page 74-79 for all available colors and effects.<sup>1</sup>

Stock Program

<b>37 720</b>	Size	P18 00 1
<b>Color/Plating</b>		
Cr. Silver Shade F (001 SSHA) /G		

<sup>1</sup> The plating resistance of effects should be considered and can be verified with the Color Chart on page 704

**41 205** Cross Baguette



Stone Size		Ring Configuration		Back Configuration		Stone Art. No.		Dimensions
Code	Description	Code	Description	Code	Description	4501	1088	
<b>04M</b>	4x2 mm, PP 18	<b>1T</b>	1R, Top	<b>C</b>	Closed	■	■	16x11.5 mm

AVAILABLE COLOR OF CRYSTALS

Please see the respective product matrix for 4501 on page 129 and 1088 XIRIUS Chaton on page 74-79 for all available colors and effects. <sup>1</sup>

<sup>1</sup> The plating resistance of effects should be considered and can be verified with the Color Chart on page 704

**47 408** Rondelle 8 mm Ball

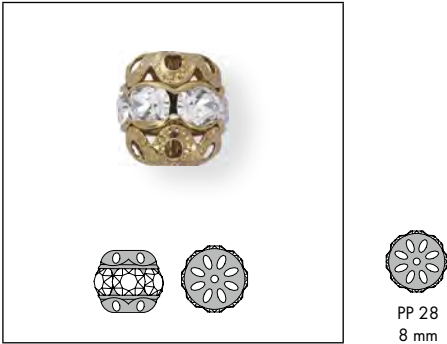

PP 28  
8 mm

Stone Size		Ring Configuration		Back Configuration		Stone Art. No.	Outside Diameter
Code	Description	Code	Description	Code	Description	1088	8 mm
P28	PP 28	00	None	C	Closed		

AVAILABLE COLOR OF CRYSTALS

Please see the respective product matrix for 1088 XIRIUS Chaton on page 74-79 for all available colors and effects.<sup>1</sup>

Stock Program

47 408

**Size**

P28 00 C

**Color/Plating**

Crystal F (001) /Z

<sup>1</sup> The plating resistance of effects should be considered and can be verified with the Color Chart on page 704

**47 510** Ball 10 mm Round



Stone Size		Ring Configuration		Back Configuration		Stone Art. No.	Outside Diameter
Code	Description	Code	Description	Code	Description		
<b>P32</b>	PP 32	<b>00</b>	None	<b>H</b>	Hole	1088	10 mm

AVAILABLE COLOR OF CRYSTALS

Please see the respective product matrix for 1088 XIRIUS Chaton on page 74-79 for all available colors and effects.<sup>1</sup>

<sup>1</sup> The plating resistance of effects should be considered and can be verified with the Color Chart on page 704

**47 603** Graduated Setting Round



SS 19, SS 29, SS 39  
20.4 mm

Stone Size		Ring Configuration		Back Configuration		Stone Art. No.	Outside Diameter
Code	Description	Code	Description	Code	Description		
<b>S19</b>	SS 19, SS 29, SS 39	<b>1T</b>	1R, Top	<b>C</b>	Closed	1088 1088 1088	20.4 mm

**Ring Configuration**

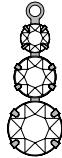

1T

AVAILABLE COLOR OF CRYSTALS

Please see the respective product matrix for 1088 XIRIUS Chaton on page 74-79 for all available colors and effects.<sup>1</sup>

Stock Program

<b>47 603</b>	<b>Size</b> S19 1TC
<b>Color/Plating</b>	
Crystal F (001) /H	■
Crystal F (001) /3	■

<sup>1</sup> The plating resistance of effects should be considered and can be verified with the Color Chart on page 704

## PRODUCT DETAILS MULTI STONE SETTINGS

Article Stone Article Number	Stone Size	Dimensions/ Diameter
<b>37 102</b> Double Setting 1088	SS 19, 39	115.8x71.1 mm
<b>37 714</b> Circle 1088	PP 18	15.6 mm
<b>37 720</b> Circle 1088	PP 18	21.4 mm
<b>41 205</b> Cross Baguette 4501, 1088	4x2 mm, PP 18	16x11.5 mm
<b>47 408</b> Rondelle Ball 8 mm 1088	PP 28	8 mm
<b>47 510</b> Rondelle Ball 10 mm 1088	PP 32	10 mm
<b>47 603</b> Graduata Setting Round 1088	SS 19, 29, 39	20.4 mm

## PRODUCT DETAILS STRETCH BRACELETS

Article Stone Article Number	Stone Size	Ring Configuration	Diameter
<b>31 E02</b> Snake Chain Stretch Bracelet 4501	7x3 mm	170 mm	55 mm
<b>37 E00</b> Bezel Stretch Chain 1088	PP 24	177.8 mm	54 mm
1088	PP 32	170 mm	55 mm
<b>37 E02</b> Catch-free Stretch Bracelet 1088	PP 32	170 mm	55 mm
<b>37 E04</b> Stretch Chain 1088	PP 24	177.8 mm	55.1 mm
1088	PP 32	173 mm	53.3 mm
<b>38 E02</b> Square Stretch Chain 4428	4 mm	170 mm	55 mm





## **CHANNELS**

These products are single Round or Fancy Stones without foiling that are fitted with a metal ring around the girdle of the stone. This gives the Channels their typical feature: the wearer is able to look "through" the Round or Fancy Stones.

ARTICLE EXPLANATION - BASE ITEM NUMBER

**57 700** Round



<b>5</b>	<b>7</b>	<b>7</b>	<b>00</b>
Product category	Stone code (type of stone used)	Setting code	Number of stones in the setting (always 2-digit code)
<b>5</b> Channels	<b>3</b> Navette <b>7</b> Round	<b>3</b> Navette <b>7</b> Round	00

ORDERING EXAMPLE & PRODUCT VARIETY EXPLANATION

<b>1</b>	<b>57 700</b>	<b>S29</b>	<b>TB</b>	<b>O</b>
Material type	Base item number	Stone size	Ring configuration	Back configuration
<b>1</b> Brass		3-digit code from respective product matrix	<b>1T</b> 1 Ring/Top <b>TB</b> 2 Rings/Top & Bottom	<b>O</b> Open
<b>F1</b>	<b>3</b>	<b>1128</b>	<b>001</b>	
Stone pattern	Plating	Base item art. no.	Color of crystal	
<b>F1</b> Crystal/color/effect	Can be added at an extra charge. <b>Z</b> No Plating <b>G</b> Gun Metal <b>3</b> Gold <b>H</b> Rhodium <b>R</b> Rose Gold	1128 4228	Please see the respective color chart at the beginning of this chapter for all available reference codes.	

53 300 Navette



Stone Size		Ring Configuration		Back Configuration		Stone Art. No.
Code	Description	Code	Description	Code	Description	
<b>10M</b>	10x5 mm	<b>1T</b>	1R, Top	<b>O</b>	Open	4228
<b>10M</b>	10x5 mm	<b>TB</b>	2R, Top/Bottom	<b>O</b>	Open	

Ring Configuration		Back Configuration	
1T	TB	Open	

AVAILABLE COLOR OF CRYSTALS

Please see the respective product matrix for 4228 XILION Navette on page 109-110 for all available colors and effects.<sup>1</sup>

<sup>1</sup> The plating resistance of effects should be considered and can be verified with the Color Chart on page 704

57 700 Round



Stone Size		Ring Configuration		Back Configuration		Stone Art. No.
Code	Description	Code	Description	Code	Description	
S29	SS 29	1T	1R, Top	O	Open	1128
S29	SS 29	TB	2R, Top/Bottom	O	Open	

Ring Configuration		Back Configuration	
1T	TB	Open	

AVAILABLE COLOR OF CRYSTALS

Please see the respective product matrix for 4228 XILION Navette on page 109-110 for all available colors and effects.<sup>1</sup>

Stock Program

Color/Plating	Size	
	S29 1T O	S29 TB O
Crystal (001) /Z	■	■
Crystal (001) /H	■	■
Crystal (001) /3	■	■
Amethyst (204) /H	■	
Emerald (205) /H	■	
Light Amethyst (212) /H	■	
Light Sapphire (211) /H		■
Peridot (214) /H	■	
Rose (209) /H	■	
Sapphire (206) /H	■	
Siam (208) /H	■	
Topaz (203) /H	■	

<sup>1</sup> The plating resistance of effects should be considered and can be verified with the Color Chart on page 704

PRODUCT DETAILS - CHANNELS

<b>Article</b>	<b>Stone Article Number</b>	<b>Stone Size</b>
<b>53 300</b> Navette		
	4228	10x5 mm
<b>57 700</b> Round		
	1128	SS 29



## **METAL BUTTONS**

These products are Round Stones that are combined with metal components to form a button.



ORDERING EXAMPLE  
& PRODUCT VARIETY EXPLANATION

**60 408** Metal Button

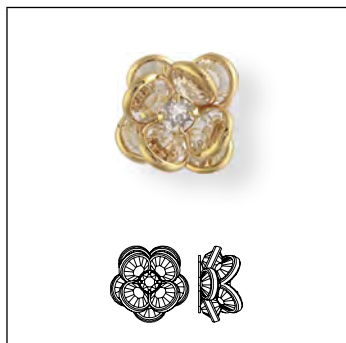

<b>1</b>	<b>60 408</b>	<b>S29</b>	<b>00</b>	<b>C</b>
Material type	Base item number	Stone size	Ring configuration	Back configuration
<b>1</b> Brass	Number above product picture <b>60</b> Metal Buttons <b>61</b> Metal Buttons	3-digit code from respective product matrix	<b>00</b> None	<b>C</b> Closed
<b>F1</b>	<b>3</b>	<b>1088</b>	<b>F</b>	<b>001 001 001</b>
Stone pattern	Plating	Base item art. no.	Foiling	Color of crystal
<b>F1</b> Crystal/color/effect	Can be added at an extra charge. <b>Z</b> No Plating <b>G</b> Gun Metal <b>3</b> Gold <b>H</b> Rhodium <b>R</b> Rose Gold	1088 1128	<b>F</b> Foiled	Please see the respective color chart at the beginning of this chapter for all available code references.  The articles are built from the bottom upwards and from the outside inwards.

Not all configurations are available for all articles. Please refer to the respective product matrix for available combinations.

60 408 Metal Button

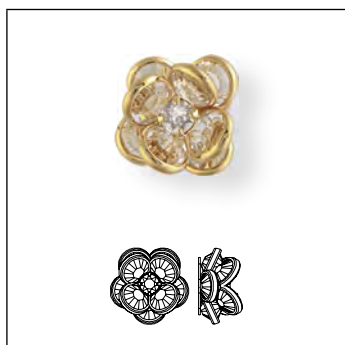

Stone Size		Ring Configuration		Back Configuration		Stone Art. No.		
Code	Description	Code	Description	Code	Description			
<b>S29</b>	SS 29, SS 29, PP 32	<b>00</b>	None	<b>C</b>	Closed	1128	1128	1088

AVAILABLE COLOR OF CRYSTALS

Please see the respective product matrix for 4228 XILION Navette on page 109-110 for all available colors and effects.<sup>1</sup>

61 019 Metal Button



Stone Size		Ring Configuration		Back Configuration		Stone Art. No.		
Code	Description	Code	Description	Code	Description			
<b>P32</b>	PP 32, PP 32, PP 24	<b>00</b>	None	<b>C</b>	Closed	1088	1088	1088

AVAILABLE COLOR OF CRYSTALS

Please see the respective product matrix for 4228 XILION Navette on page 109-110 for all available colors and effects.<sup>1</sup>

<sup>1</sup> The plating resistance of effects should be considered and can be verified with the Color Chart on page 704

PRODUCT DETAILS - METAL BUTTONS

<b>Article</b>	<b>Stone Article Number</b>	<b>Stone Size</b>
<b>60 408</b> Metal Button	1128, 1088	SS 29, PP 32
<b>61 019</b> Metal Button	1088	PP 24, PP 32



## **RONDELLES**

Rondelles are Round Stones with metal parts that can be used as a spacer between Beads or Crystal Pearls.

ARTICLE EXPLANATION - BASE ITEM NUMBER

**77 503 - 77 510** Rondelle Spacer



<b>7</b>	<b>7</b>	<b>5</b>	<b>04</b>
Product category	Stone code (type of stone used)	Setting code	Outer diameter (always 2-digit code)
<b>7</b> Rondelles	<b>7</b> Rondelle	<b>5</b> Spacer <b>6</b> Square <b>7</b> Bar	03 04 05 06 07 08 10 12 19

ORDERING EXAMPLE  
& PRODUCT VARIETY EXPLANATION

<b>1</b>	<b>77 504</b>	<b>P13</b>	<b>00</b>	<b>0</b>
Stone pattern	Base item number	Stone size	Ring configuration	Back configuration
<b>F1</b> Crystal/color/ effect		3-digit code from respective product matrix	<b>00</b> None	<b>0</b> None <b>H</b> Hole
<b>F1</b>	<b>Z</b>	<b>1088</b>	<b>F</b>	<b>001</b>
Stone pattern	Plating	Base item art. no.	Foiling	Color of crystal
<b>F1</b> Crystal/color/ effect	Can be added at an extra charge.	1028 1088	<b>F</b> Foiled	Please see the respective color chart at the beginning of this chapter for all available reference codes.
	<b>Z</b> No Plating <b>G</b> Gun Metal <b>3</b> Gold <b>H</b> Rhodium <b>R</b> Rose Gold			

Not all configurations are available for all articles. Please refer to the respective product matrix for available combinations.

77 503 – 77 510 Rondelle Spacer



Base Item No.	Stone Size		Ring Configuration		Back Configuration		Stone Art.No.	
	Code	Description	Code	Description	Code	Description	1028	1088
77 503	P11	PP 11	00	None	0	None	■	■
77 504	P13	PP 13	00	None	0	None	■	■
77 505	P16	PP 16	00	None	0	None	■	■
77 506	P20	PP 20	00	None	0	None	■	■
77 506	P24	PP 24	00	None	0	None	■	■
77 507	P24	PP 24	00	None	0	None	■	■
77 508	P24	PP 24	00	None	0	None	■	■
77 510	P25	PP 25	00	None	0	None	■	■

AVAILABLE COLOR OF CRYSTALS

Please see the respective product matrix for 1028 XILION Chaton on page 71–73 and 1088 XIRIUS Chaton on page 74–79 for all available colors and effects.<sup>1</sup>

Stock Program

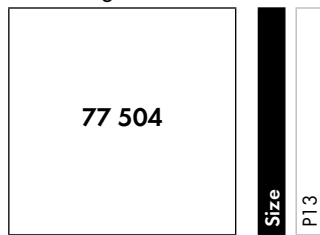

Color/Plating

- Crystal F (001) /3
- Crystal F (001) /H
- Crystal AB F (001 AB) /3
- Crystal AB F (001 AB) /H

Stock Program

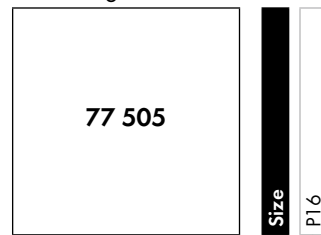

Color/Plating

- Crystal F (001) /Z
- Crystal F (001) /3
- Crystal F (001) /H

Stock Program

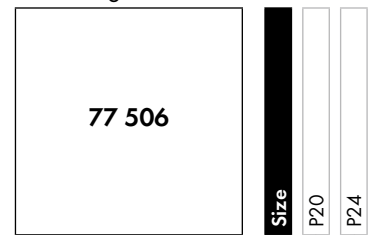

Color/Plating

- Crystal F (001) /Z
- Crystal F (001) /3
- Crystal F (001) /H
- Crystal AB F (001 AB) /3
- Crystal AB F (001 AB) /H

<sup>1</sup> The plating resistance of effects should be considered and can be verified with the Color Chart on page 704



# CUPCHAINS & FINDINGS

# RONDELLES

Stock Program

77 507

Size

P24

Color/Plating

Crystal F (001) /Z

Crystal F (001) /H

Stock Program

77 508

Size

P24

Color/Plating

Crystal F (001) /Z

Crystal F (001) /3

Crystal F (001) /H

Stock Program

77 510

Size

P25

Color/Plating

Crystal F (001) /Z

Crystal F (001) /H

## 77 510 & 77 512 BeCharmed Rondelle

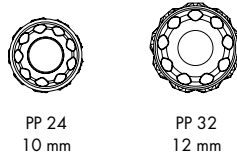
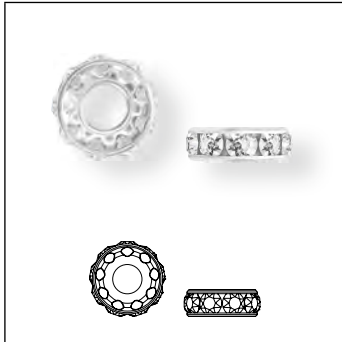

Base Item No.	Stone Size		Ring Configuration		Back Configuration		Stone Art.No.
	Code	Description	Code	Description	Code	Description	
77 510	P24	PP 24	00	None	H	Hole	1088
77 512	P32	PP 32	00	None	H	None	1088

## AVAILABLE COLOR OF CRYSTALS

Please see the respective product matrix for 1088 XIRIUS Chaton on page 74-79 for all available colors and effects.<sup>1</sup>

Stock Program

77 510

Size

P24

Color/Plating

Crystal F (001) /Z

Stock Program

77 512

Size

P32

Color/Plating

Crystal F (001) /Z

Crystal F (001) /H

<sup>1</sup> The plating resistance of effects should be considered and can be verified with the Color Chart on page 704

77 604 – 77 608 Rondelle Square



Base Item No.	Stone Size		Ring Configuration		Back Configuration		Stone Art.No.	
	Code	Description	Code	Description	Code	Description	1028	1088
77 604	P13	PP 13	00	None	0	None	■	
77 606	P18	PP 18	00	None	0	None		■
77 608	P24	PP 24	00	None	0	None		■

AVAILABLE COLOR OF CRYSTALS

Please see the respective product matrix for 1028 on page 71–73 and 1088 XIRIUS Chaton on page 74–79 for all available colors and effects.<sup>1</sup>

Stock Program

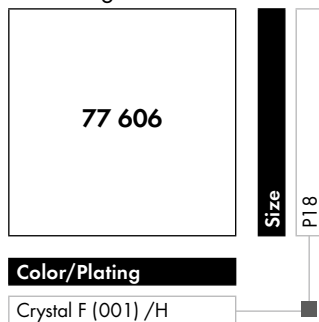

<sup>1</sup> The plating resistance of effects should be considered and can be verified with the Color Chart on page 704

77 710 & 77 719 Rondelle Bar

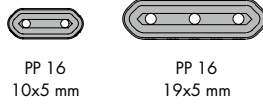

Base Item No.	Stone Size		Ring Configuration		Back Configuration		Stone Art.No.
	Code	Description	Code	Description	Code	Description	
77 710	P16	PP 16	00	None	0	None	1088
77 719	P16	PP 16	00	None	0	None	

AVAILABLE COLOR OF CRYSTALS

Please see the respective product matrix for 1088 XIRIUS Chaton on page 74-79 for all available colors and effects.<sup>1</sup>

Stock Program

77 710

Size P16

Color/Plating  
Crystal F (001) /Z

Stock Program

77 719

Size P16

Color/Plating  
Crystal F (001) /Z

<sup>1</sup> The plating resistance of effects should be considered and can be verified with the Color Chart on page 704

## PRODUCT DETAILS - RONDELLES

Article Stone Article Number	Stone Size	Number of Stones	Outside Diameter
<b>77 503</b> Rondelle Spacer 1028	PP 11	5	3 mm
<b>77 504</b> Rondelle Spacer 1028	PP 13	6	4 mm
<b>77 505</b> Rondelle Spacer 1088	PP 16	6	5 mm
<b>77 506</b> Rondelle Spacer 1088	PP 20	6	6 mm
1088	PP 24	5	6 mm
<b>77 507</b> Rondelle Spacer 1088	PP 24	6	7 mm
<b>77 508</b> Rondelle Spacer 1088	PP 24	7	8 mm
<b>77 510</b> Rondelle Spacer 1088	PP 25	9	10 mm
<b>77 510</b> BeCharmed Rondelle 1088	PP 24	9	10 mm
<b>77 512</b> BeCharmed Rondelle 1088	PP 32	9	12 mm
<b>77 604</b> Rondelle Square 1028	PP 13	8	4 mm
<b>77 606</b> Rondelle Square 1088	PP 18	8	6 mm
<b>77 608</b> Rondelle Square 1088	PP 24	8	8 mm
<b>77 710</b> Rondelle Bar 1088	PP 16	5	10x5 mm
<b>77 719</b> Rondelle Bar 1088	PP 16	8	19x5 mm



## **LINKED FINDINGS**

Linked Findings incorporate Channels (Round Stones without foiling that are fitted with a metal ring around the girdle of the Stone) which can be ordered by the meter.

ORDERING EXAMPLE & PRODUCT VARIETY EXPLANATION

**90 005** Round



<b>1</b>	<b>90 005</b>	<b>S29</b>	<b>00</b>	<b>O</b>
Stone pattern	Base item number	Stone size	Ring configuration	Back configuration
<b>F1</b> Crystal/color/effect	Number above product picture always starting with 90	3-digit code from respective product matrix	<b>00</b> None	<b>O</b> Open
<b>F1</b>	<b>3</b>	<b>1128</b>	<b>001</b>	
Stone pattern	Plating	Base item art. no.	Color of crystal	
<b>F1</b> Crystal/color/effect	Can be added at an extra charge.	1088	Please see the respective color chart at the beginning of this chapter for all available reference codes.	
<b>F2</b> 2 alternate colors		1122		
<b>F3</b> 3 alternate colors		1128		
<b>F4</b> 4 alternate colors	<b>Z</b> No Plating			
<b>F5</b> 5 alternate colors	<b>G</b> Gun Metal			
	<b>3</b> Gold			
	<b>H</b> Rhodium			
	<b>R</b> Rose Gold			

Not all configurations are available for all articles. Please refer to the respective product matrix for available combinations.

90 001 Round



Stone Size		Ring Configuration		Back Configuration		Stone Art. No.
Code	Description	Code	Description	Code	Description	
<b>P24</b>	PP 24	<b>00</b>	None	<b>O</b>	Open	1088

AVAILABLE COLOR OF CRYSTALS

Please see the respective product matrix for 1088 XIRIUS Chaton on page 74-79 for all available colors and effects.<sup>1</sup>

<sup>1</sup> The plating resistance of effects should be considered and can be verified with the Color Chart on page 704



90 005 Round



Stone Size		Ring Configuration		Back Configuration		Stone Art. No.	
Code	Description	Code	Description	Code	Description		
S29	SS 29	00	None	O	Open	1122	1128

AVAILABLE COLOR OF CRYSTALS

Please see the respective product matrix for 1122 on page 80-81 and 1128 on page 82 for all available colors and effects.<sup>1</sup>

Stock Program

90 005

**Size**

S29 00 O (1128)

**Color/Plating**

- Crystal F (001) /Z
- Crystal F (001) /H
- Crystal F (001) /3

<sup>1</sup> The plating resistance of effects should be considered and can be verified with the Color Chart on page 704

PRODUCT DETAILS - LINKED FINDINGS

Article Stone Article Number	Stone Size	Stones per meter	Stones per foot
<b>90 001</b> Round 1088	PP 24	97	30
<b>90 005</b> Round 1122	SS 29	65	20
1128	SS 29	65	20